

Impregum™ Penta™ H DuoSoft™ Impregum™ Garant™ L DuoSoft™

Polyether Impression Material
Polyether Abformmaterial

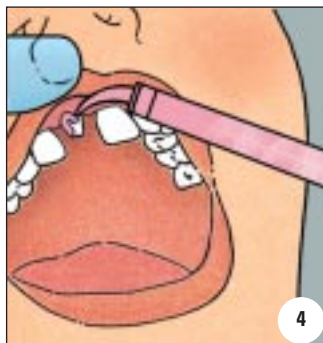

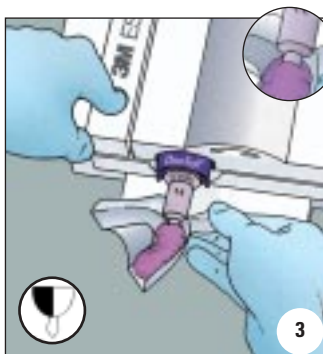
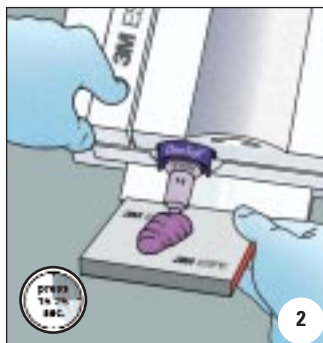
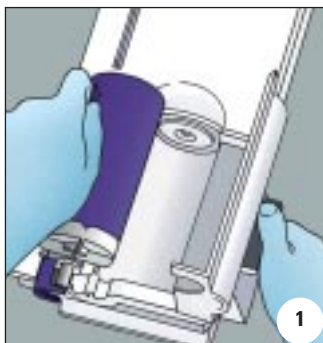
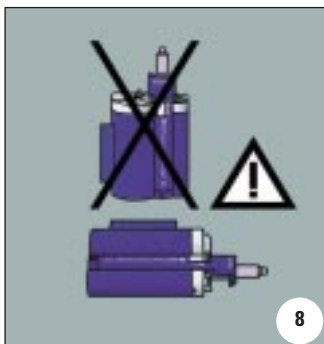
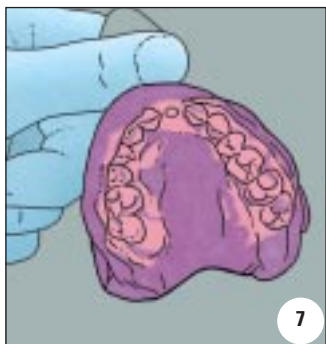
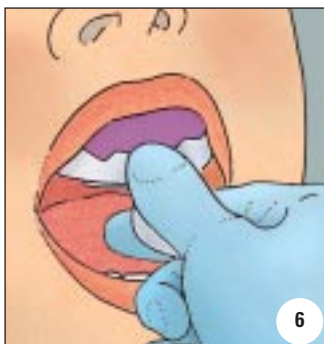
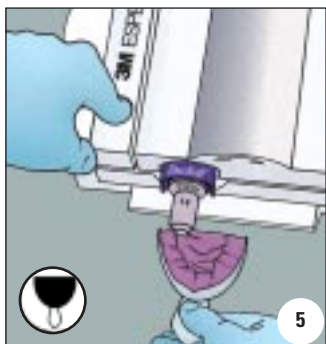

3M ESPE

3M ESPE AG
Dental Products
82229 Seefeld
Germany

3M ESPE
Dental Products
St. Paul,
MN 55144-1000

3M, ESPE, Impregum, Penta, Garant, DuoSoft are trademarks of 3M or 3M ESPE AG.
© 3M 2002. All rights reserved.

44 0007 35173/01 (10.02)